

Deluxe Leisure Chair (Floor-standing) Assembly Instructions

RETAIN FOR FUTURE REFERENCE

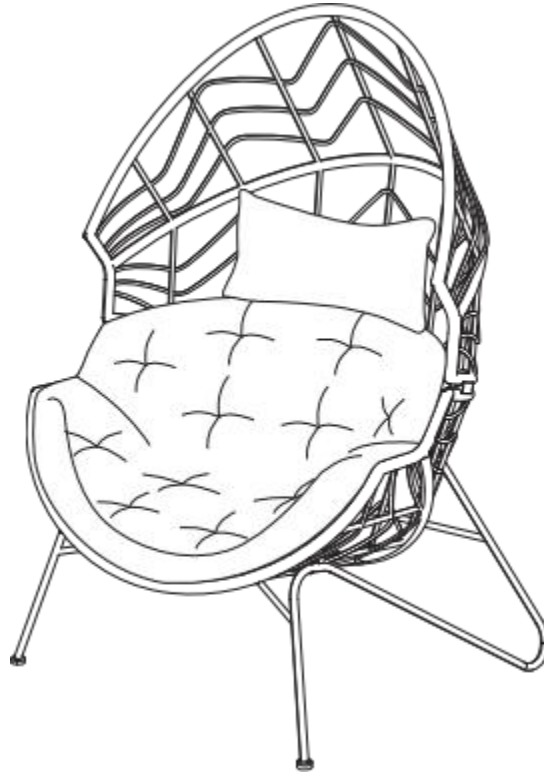

Assembly notes







Locate all parts and identify them against these instructions before disposing of packing

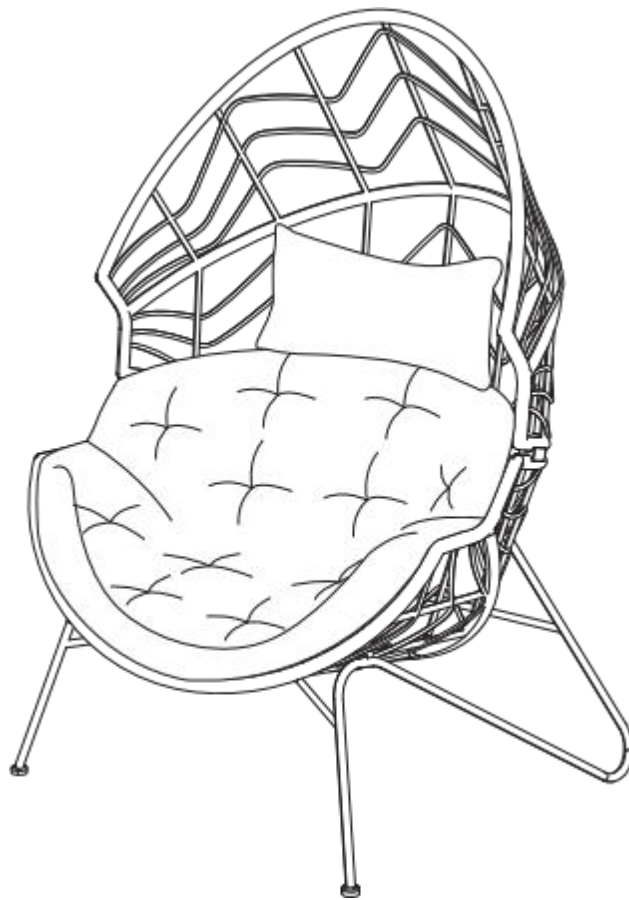



Important Tip: DON'T TIGHTEN THINGS UP AT FIRST! During assembly, at first only fit screws part way in, in order to allow furniture parts to be re-positioned slightly relative to each other as necessary to align all screw holes and thus for screws to locate them and fasten easily. When all screws are in position, then tighten them all.



Deluxe Leisure Chair



chair backrest (upper part)	chair backrest (under part)	right chair leg	left chair leg	connecting bar	cushion	small cushion with binds
						
Ax1	Bx1	Cx1	Dx1	Ex1	Fx1	Gx1

screw	screw	screw	washer	hex key
				
Hx4	Ix2	Jx6	Kx12	Lx1

Remember! Locate all the screws in their positions before tightening them all up!

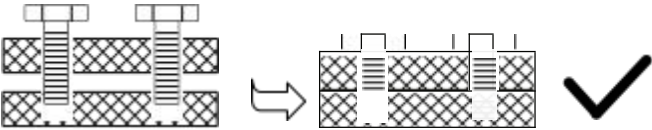

Deluxe Leisure Chair

1

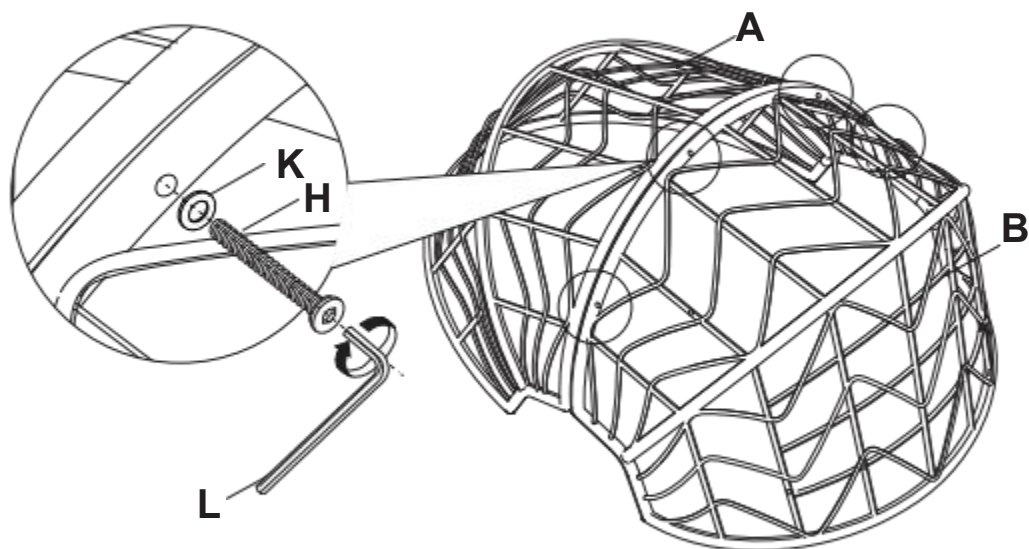

2

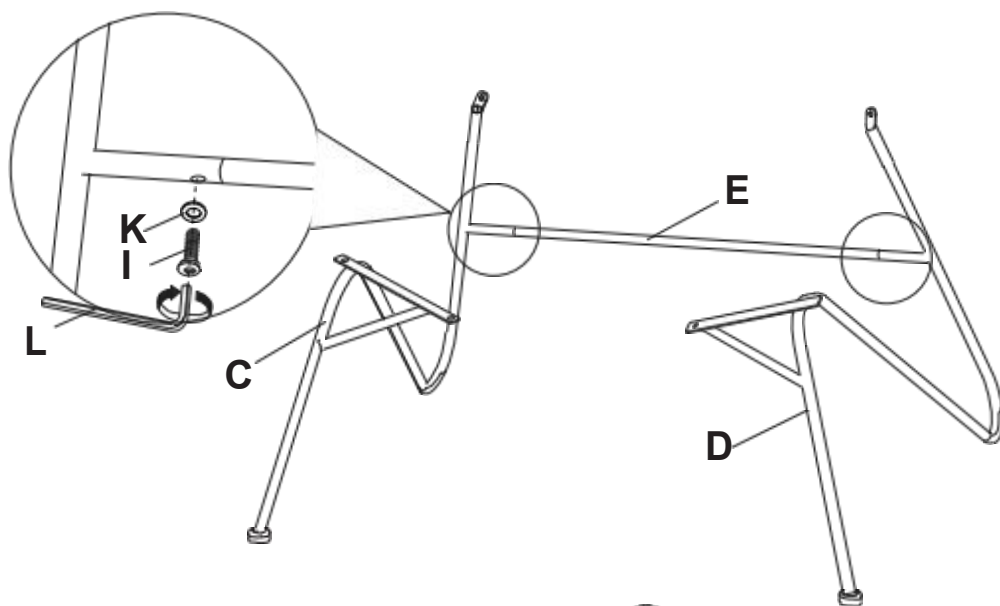

3

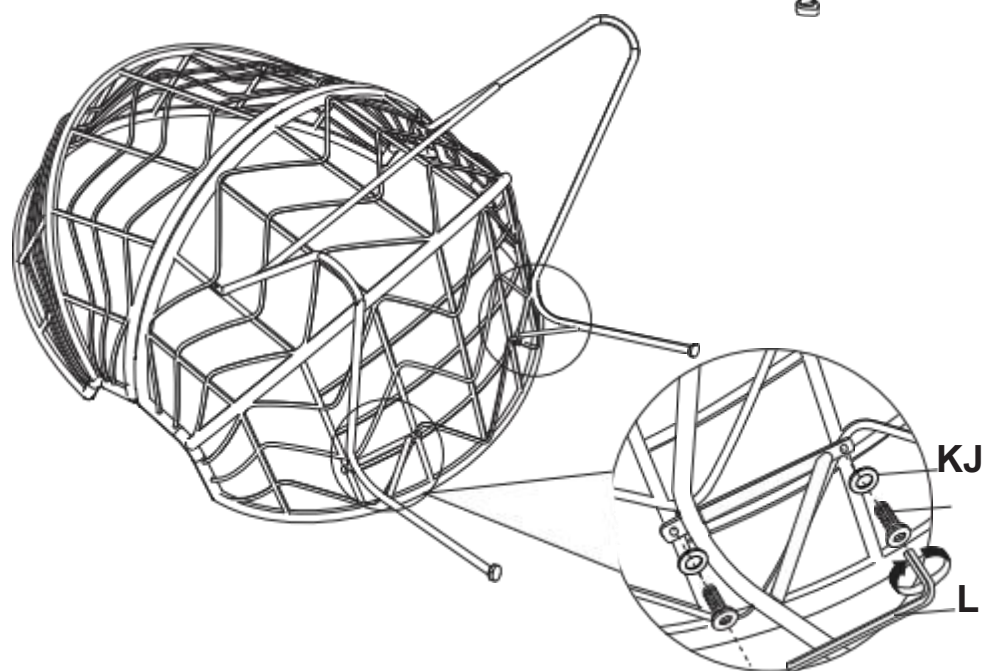

Deluxe Leisure Chair

4

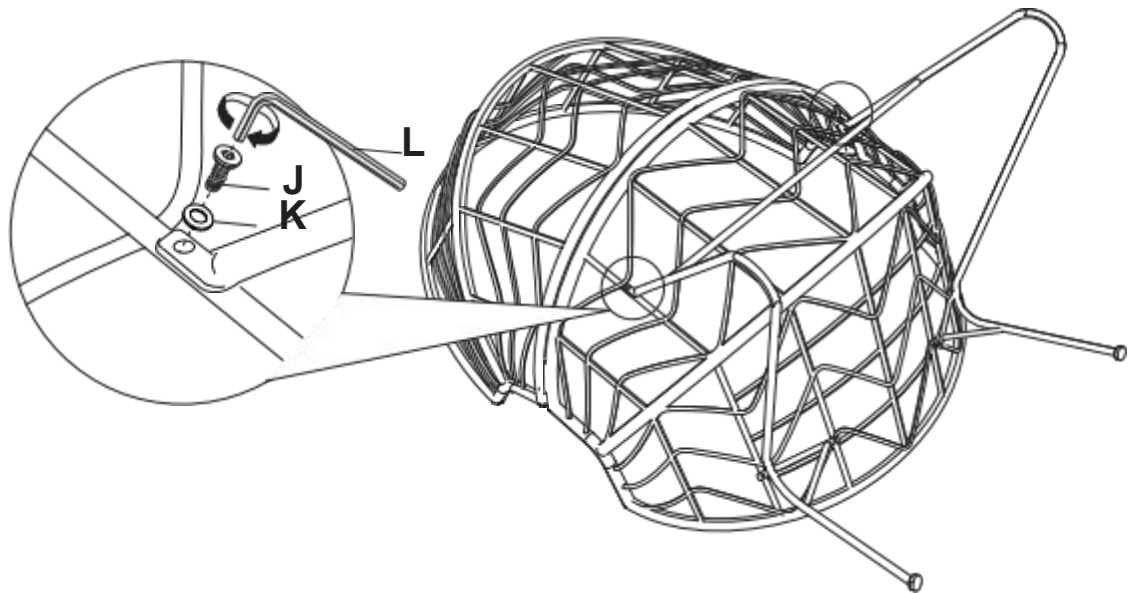

5

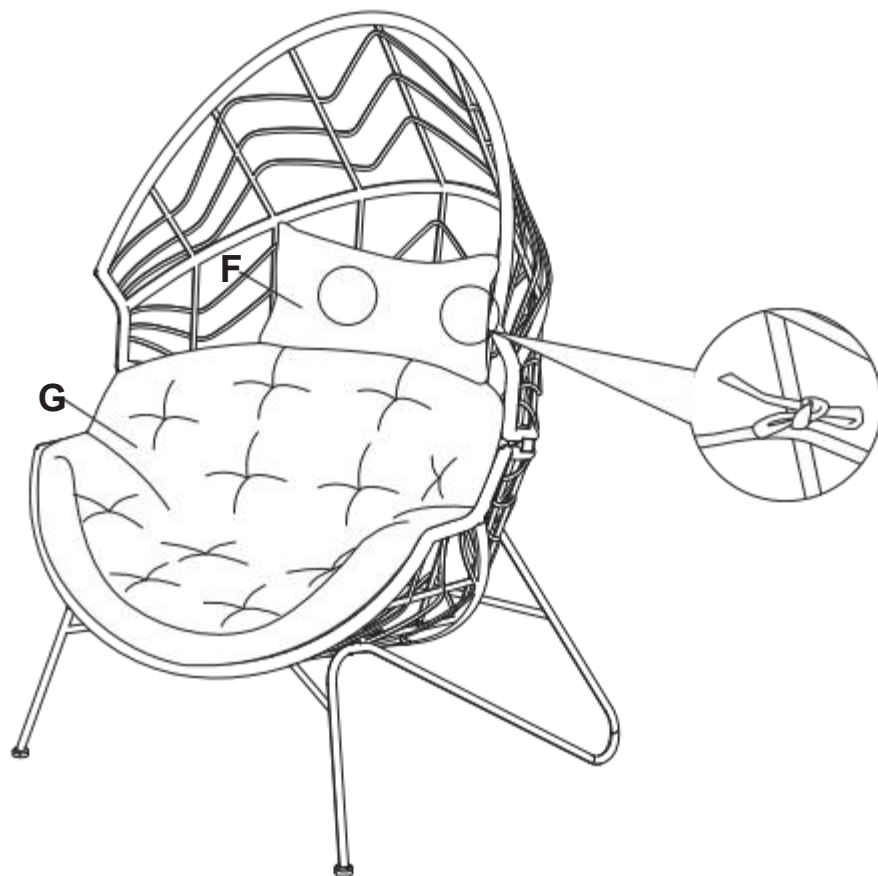

CARE AND CLEANING:

- 1 . TO CLEAN FRAME , WIPE WITH DAMP CLOTH . DO NOT USE BLEACH , ACID SOLVENTS OR ABRASIVE CLEANERS .
- 2 . SPONGE-CLEAN CUSHION ONLY-NOT REMOVABLE
- 4 . PERIODICALLY CHECK AND ENSURE THAT ALL THE SCREWS ARE FULLY TIGHTENED . IF ANY PART BECOMES IRREPARABLY LOOSE OR DAMAGED , CEASE USE OF THE CHAIR IMMEDIATELY FOR SAFETY REASONS .